

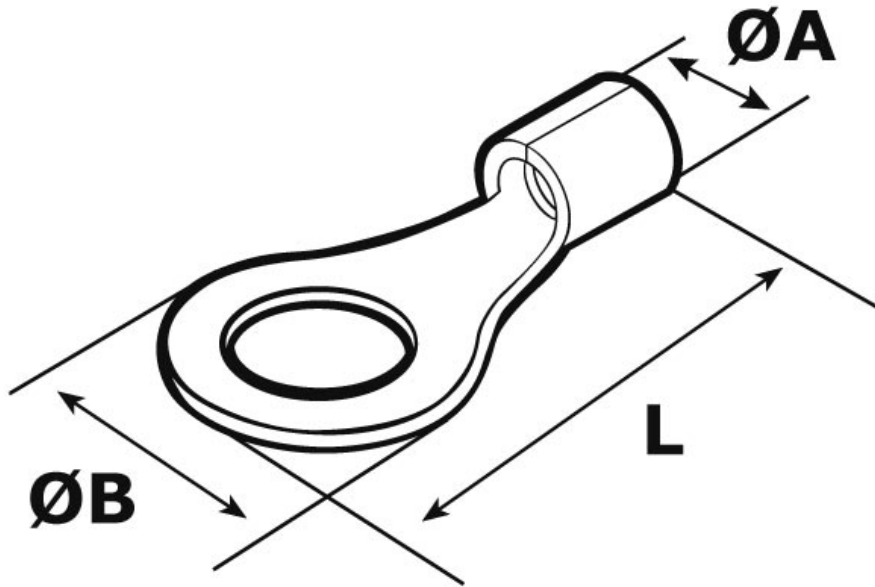

SCHEMA ARTICOLO

Articolo: B 1585 R - Codice EZ: 427992

24/07/2024



ARTICOLO	sezione mm ²	sezione AWG	per vite	ØA mm	ØB mm	L mm
B 1585 R	0,75 - 1,5	18 - 16	M8	1,8	14	23

Materiale: capicorda in rame stagnato (rame 99,95%).

Tutte le informazioni e i dati riportati sono indicativi e possono essere soggetti a variazioni senza preavviso

ELEKTROZUBEHÖR SPA

Sede:
Via F.lli Bronzetti, 24
20129 Milano (Italy)

Tel.: +39 02 701471
C.F. e P. IVA: 00729140152
Capitale Sociale: € 260.000

Centro logistico:
Via Cadorna, 66/A
20055 Vimodrone MI

Registro imprese: n° 92394 Tribunale di Milano
R.E.A.: 460657 - INTRASTAT: IT 00729140152
Posizione Import: MI 007993

