

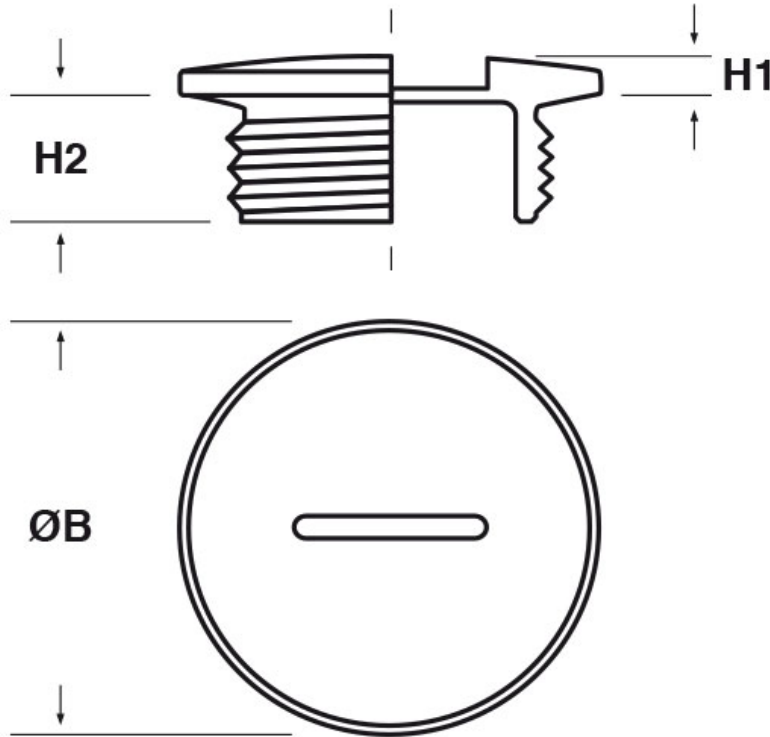

SCHEMA ARTICOLO

Articolo: P-TFC M2506.32 - Codice EZ: 169693

20/07/2024



ARTICOLO	colore	materiale	filetto passo	filetto valore	ØB mm	H1 mm	H2 mm
P-TFC M2506.32	nero RAL 9005	PA 6	Metrico	25	32	3	8

Materiale: poliammide 6 (PA 6) rinforzato con fibra di vetro (25%), polistirene (PS).

Colore: grigio chiaro RAL 7035, grigio scuro RAL 7001, nero RAL 9005.

Temperatura d'uso: -30°C / +120°C (PA 6), -20°C / +70°C (PS)

Protezione IP: IP 65.

Tutte le informazioni e i dati riportati sono indicativi e possono essere soggetti a variazioni senza preavviso

ELEKTROZUBEHÖR SPA

Sede:
Via F.lli Bronzetti, 24
20129 Milano (Italy)

Tel.: +39 02 701471
C.F. e P. IVA: 00729140152
Capitale Sociale: € 260.000

Centro logistico:
Via Cadorna, 66/A
20055 Vimodrone MI

Registro imprese: n° 92394 Tribunale di Milano
R.E.A.: 460657 - INTRASTAT: IT 00729140152
Posizione Import: MI 007993

