

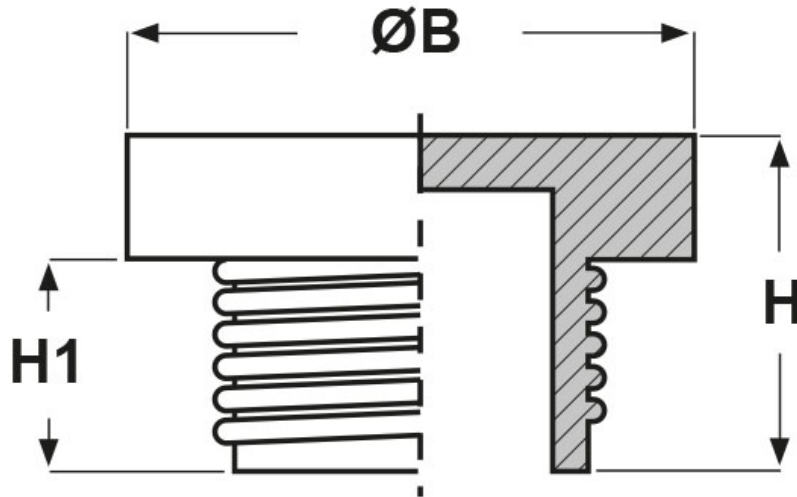

SCHEMA ARTICOLO

Articolo: TPL U1116.14 - Codice EZ: N.D

25/07/2024



ARTICOLO	ØB mm	H mm	H1 mm	adatto a filetto UNF/JIC
TPL U1116.14	33,3	18,3	13,7	1" 1/16x14

Materiale: polietilene PE-LD.

Colore: rosso.

Tutte le informazioni e i dati riportati sono indicativi e possono essere soggetti a variazioni senza preavviso

ELEKTROZUBEHÖR SPA

Sede:
Via F.lli Bronzetti, 24
20129 Milano (Italy)

Tel.: +39 02 701471
C.F. e P. IVA: 00729140152
Capitale Sociale: € 260.000

Centro logistico:
Via Cadorna, 66/A
20055 Vimodrone MI

Registro imprese: n° 92394 Tribunale di Milano
R.E.A.: 460657 - INTRASTAT: IT 00729140152
Posizione Import: MI 007993

