

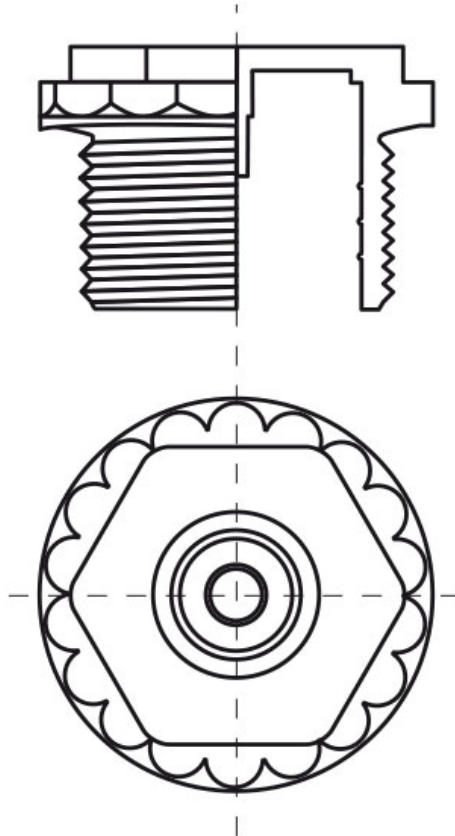

SCHEMA ARTICOLO

Articolo: P-TFS PG2164 - Codice EZ: N.D

24/07/2024



ARTICOLO	filetto passo	filetto valore
P-TFS PG2164	PG	21

Materiale: polietilene PE-LD.

Temperatura d'uso: -20°C / +70°C

Colore: grigio chiaro RAL 7035.

Tutte le informazioni e i dati riportati sono indicativi e possono essere soggetti a variazioni senza preavviso

ELEKTROZUBEHÖR SPA

Sede:
Via F.lli Bronzetti, 24
20129 Milano (Italy)

Tel.: +39 02 701471
C.F. e P. IVA: 00729140152
Capitale Sociale: € 260.000

Centro logistico:
Via Cadorna, 66/A
20055 Vimodrone MI

Registro imprese: n° 92394 Tribunale di Milano
R.E.A.: 460657 - INTRASTAT: IT 00729140152
Posizione Import: MI 007993

