

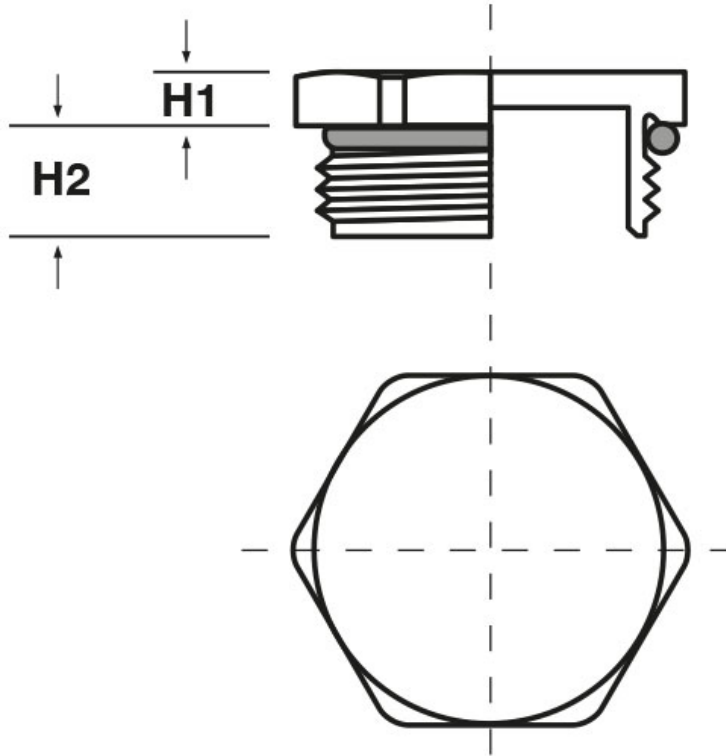

SCHEMA ARTICOLO

Articolo: TCE OR PG21.29 L - Codice EZ: 185173

27/07/2024



ARTICOLO	filetto passo	filetto valore	H1 mm	H2 mm	chiave mm
TCE OR PG21.29 L	PG	21	4	12	29

Materiale: tappo in ottone nichelato, O-Ring in nitrile 70 Sh A.

Protezione IP: IP 68.

Temperatura d'uso: -25°C / +120°C

Tutte le informazioni e i dati riportati sono indicativi e possono essere soggetti a variazioni senza preavviso

ELEKTROZUBEHÖR SPA

Sede:
Via F.lli Bronzetti, 24
20129 Milano (Italy)

Tel.: +39 02 701471
C.F. e P. IVA: 00729140152
Capitale Sociale: € 260.000

Centro logistico:
Via Cadorna, 66/A
20055 Vimodrone MI

Registro imprese: n° 92394 Tribunale di Milano
R.E.A.: 460657 - INTRASTAT: IT 00729140152
Posizione Import: MI 007993

