

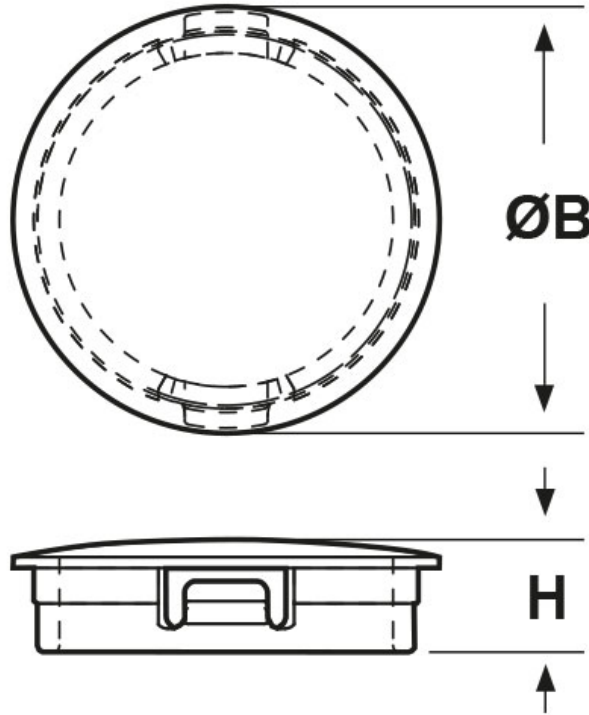

SCHEDA ARTICOLO

Articolo: SP-312 - Codice EZ: 143352

14/08/2024



ARTICOLO	Ø foro montaggio mm	spessore telaio max mm	ØB mm	H mm
SP-312	7,9	1,6	9,5	6,4

Materiale: poliammide 6/6.

Colore: nero.

Temperatura d'uso: max +105°C

Infiammabilità: antifiama e autoestinguente UL94-V2.



Tutte le informazioni e i dati riportati sono indicativi e possono essere soggetti a variazioni senza preavviso

ELEKTROZUBEHÖR SPA

Sede:
Via F.lli Bronzetti, 24
20129 Milano (Italy)

Tel.: +39 02 701471
C.F. e P. IVA: 00729140152
Capitale Sociale: € 260.000

Centro logistico:
Via Cadorna, 66/A
20055 Vimodrone MI

Registro imprese: n° 92394 Tribunale di Milano
R.E.A.: 460657 - INTRASTAT: IT 00729140152
Posizione Import: MI 007993

