

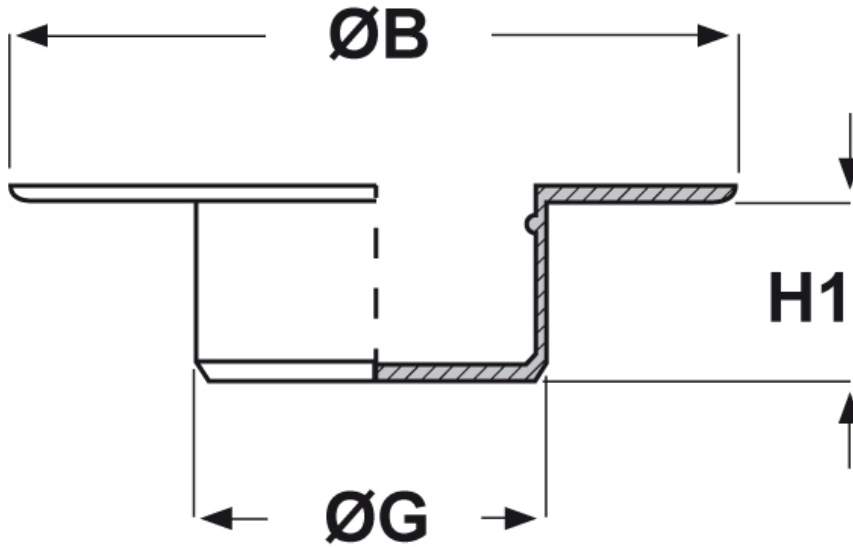

SCHEMA ARTICOLO

Articolo: ST-FL 41 - Codice EZ: N.D

27/07/2024



ARTICOLO	$\varnothing G$ mm	$\varnothing B$ mm	H1 mm
ST-FL 41	41	52	25,5

Materiale: polietilene Ld-PE.

Colore: naturale.

Tutte le informazioni e i dati riportati sono indicativi e possono essere soggetti a variazioni senza preavviso

ELEKTROZUBEHÖR SPA

Sede:
Via F.lli Bronzetti, 24
20129 Milano (Italy)
Tel.: +39 02 701471
C.F. e P. IVA: 00729140152
Capitale Sociale: € 260.000

Centro logistico:
Via Cadorna, 66/A
20055 Vimodrone MI

Registro imprese: n° 92394 Tribunale di Milano
R.E.A.: 460657 - INTRASTAT: IT 00729140152
Posizione Import: MI 007993

