

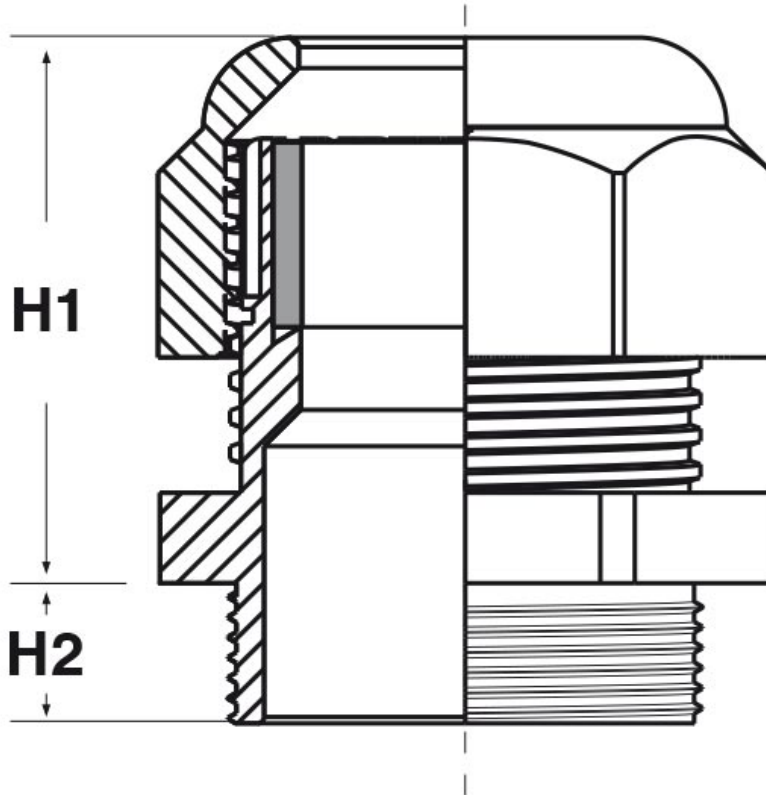

SCHEDA ARTICOLO

Articolo: RTC-S M2504.9.13 L8 - Codice EZ: N.D

22/07/2024



ARTICOLO	colore	filetto passo	filetto valore	Ø est. cavo min - max mm	chiave mm	H1 mm	H2 mm
RTC-S M2504.9.13 L8	grigio RAL 7035	Metrico	25x1,5	9 - 13	29	37,7	8

Materiale: pressacavo e O-Ring integrato in poliammide 6, guarnizione in cloroprene.

Colore: grigio chiaro RAL 7035, grigio scuro RAL 7001, nero RAL 9005.

Guarnizione: -S (per serraggio lamellare).

Temperatura d'uso: -20°C / +100°C (con punte fino a +150°C)

Protezione IP: IP 66 / IP 68 (fino a 5 bar), Type 4X (UL 50E).

Infiammabilità: antifiama e autoestinguente UL94-V2.

Normative e Certificazioni: VDE (EN 62444), UL (UL 514B, CSA C22.2 Nr. 18.3-12 e 94.2-15), c-CSA-us (CSA C22.2), DNV GL (EN 62444). Alcune normative potrebbero non coprire tutte le dimensioni; si prega di informarsi presso il nostro ufficio vendite.



Tutte le informazioni e i dati riportati sono indicativi e possono essere soggetti a variazioni senza preavviso

ELEKTROZUBEHÖR SPA

Sede:
Via F.lli Bronzetti, 24
20129 Milano (Italy)

Tel.: +39 02 701471
C.F. e P. IVA: 00729140152
Capitale Sociale: € 260.000

Centro logistico:
Via Cadorna, 66/A
20055 Vimodrone MI

Registro imprese: n° 92394 Tribunale di Milano
R.E.A.: 460657 - INTRASTAT: IT 00729140152
Posizione Import: MI 007993

