

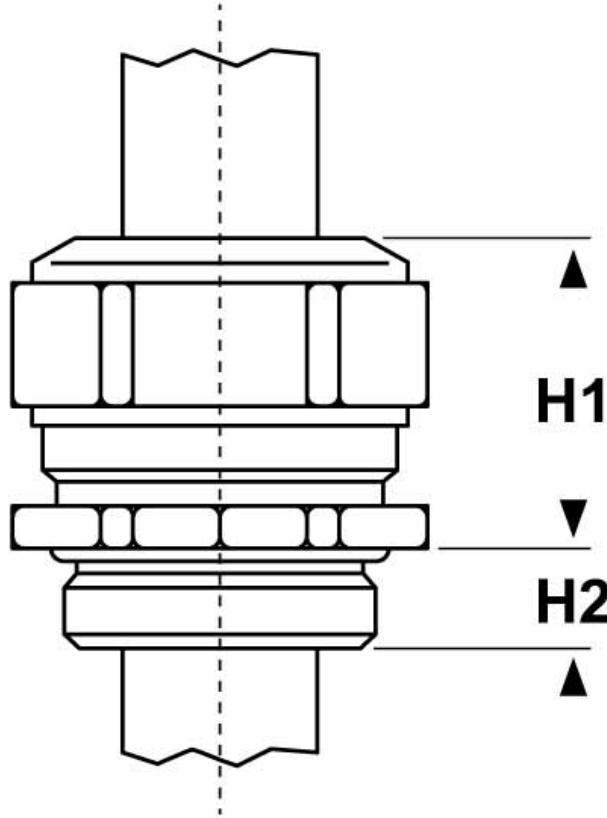

**SCHEMA ARTICOLO**

Articolo: 1301.29.260.070 - Codice EZ: N.D

25/07/2024



ARTICOLO	filetto passo	filetto valore	Ø est. cavo min - max mm	chiave mm	H1 mm	H2 mm
1301.29.260.070	PG	29	23x4 - 26x7	46	31	12

Materiale: pressacavo in ottone nichelato, guarnizione in TPE, O-Ring in NBR.

Guarnizione: -PCP (a "fungo" per cavi piatti).

Temperatura d'uso: -40°C / +100°C

Protezione IP: IP 68

Normative e Certificazioni: EAC.



Tutte le informazioni e i dati riportati sono indicativi e possono essere soggetti a variazioni senza preavviso

**ELEKTROZUBEHÖR SPA**

**Sede:**  
Via F.lli Bronzetti, 24  
20129 Milano (Italy)

Tel.: +39 02 701471  
C.F. e P. IVA: 00729140152  
Capitale Sociale: € 260.000

**Centro logistico:**  
Via Cadorna, 66/A  
20055 Vimodrone MI

Registro imprese: n° 92394 Tribunale di Milano  
R.E.A.: 460657 - INTRASTAT: IT 00729140152  
Posizione Import: MI 007993

