

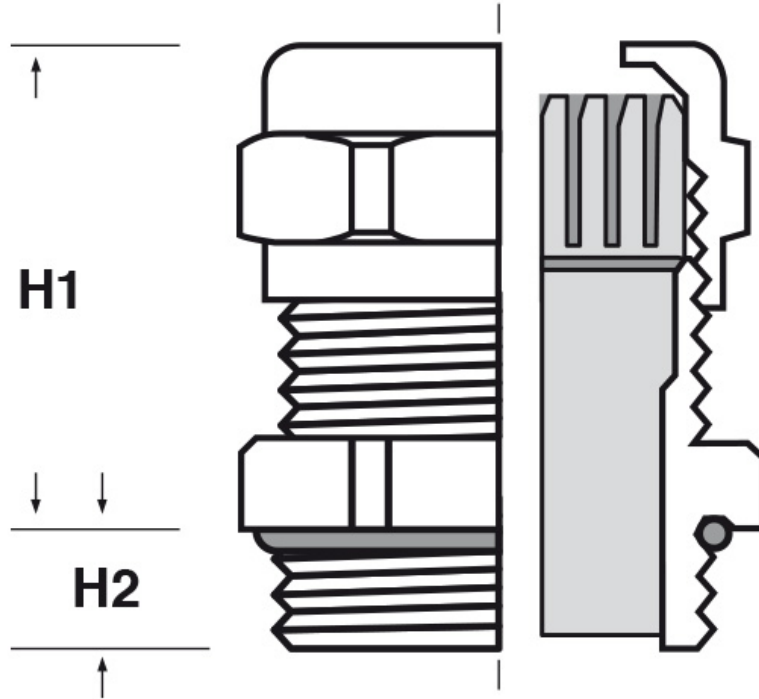

### SCHEMA ARTICOLO

Articolo: MET-S M50.22.35 - Codice EZ: 176413

01/08/2024



ARTICOLO	filetto passo	filetto valore	Ø est. cavo min - max mm	chiave mm	H1 mm	H2 mm
MET-S M50.22.35	Metrico	50x1,5	22 - 35	55	37	9

Materiale: pressacavo in ottone nichelato, boccia lamellare in poliammide 6 completa di O-Ring, O-Ring in Nitrile 70 Sh A, guarnizione in EPDM.

Guarnizione: -S (per serraggio lamellare)

Temperatura d'uso: -40°C / +100°C

Protezione IP: IP 66, IP 68.



Tutte le informazioni e i dati riportati sono indicativi e possono essere soggetti a variazioni senza preavviso

### ELEKTROZUBEHÖR SPA

**Sede:**  
Via F.lli Bronzetti, 24  
20129 Milano (Italy)

Tel.: +39 02 701471  
C.F. e P. IVA: 00729140152  
Capitale Sociale: € 260.000

**Centro logistico:**  
Via Cadorna, 66/A  
20055 Vimodrone MI

Registro imprese: n° 92394 Tribunale di Milano  
R.E.A.: 460657 - INTRASTAT: IT 00729140152  
Posizione Import: MI 007993

