

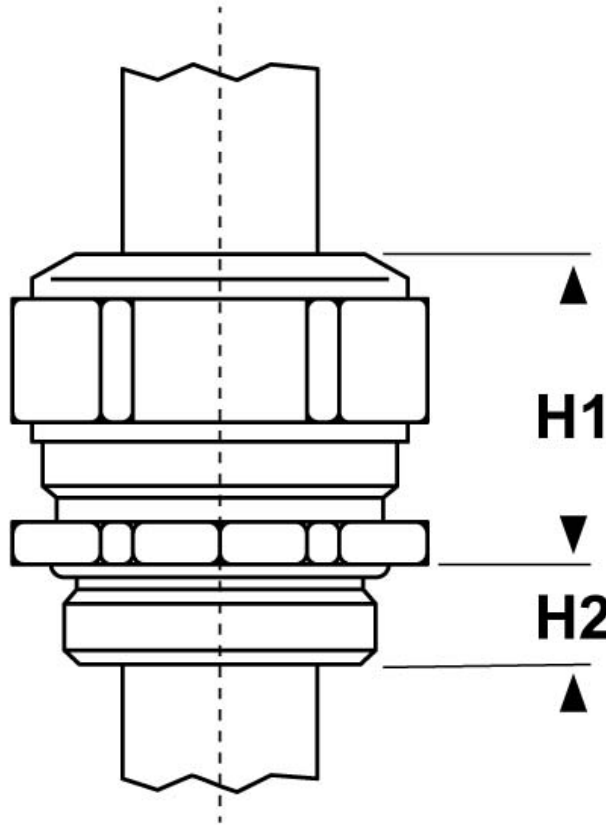

**SCHEMA ARTICOLO**

Articolo: 1000.36.91.350 - Codice EZ: N.D

27/07/2024



ARTICOLO	guarnizione	filetto passo	filetto valore	Ø est. cavo min - max mm	chiave mm	H1 mm	H2 mm
1000.36.91.350	-FCP	PG	36	30,5 - 35	50	32	8

Materiale: pressacavo in ottone nichelato, guarnizione in FPM, O-Ring in FPM.	Guarnizione: -FCP (a "fungo" corta), -FC2P (a "fungo" corta e a due elementi).
Temperatura d'uso: -40°C / +200°C	Protezione IP: IP 68 (fino a 10 bar) / IP 69
Normative e Certificazioni: EAC.	



Tutte le informazioni e i dati riportati sono indicativi e possono essere soggetti a variazioni senza preavviso

**ELEKTROZUBEHÖR SPA**

**Sede:**  
Via F.lli Bronzetti, 24  
20129 Milano (Italy)  
Tel.: +39 02 701471  
C.F. e P. IVA: 00729140152  
Capitale Sociale: € 260.000

**Centro logistico:**  
Via Cadorna, 66/A  
20055 Vimodrone MI

Registro imprese: n° 92394 Tribunale di Milano  
R.E.A.: 460657 - INTRASTAT: IT 00729140152  
Posizione Import: MI 007993

