

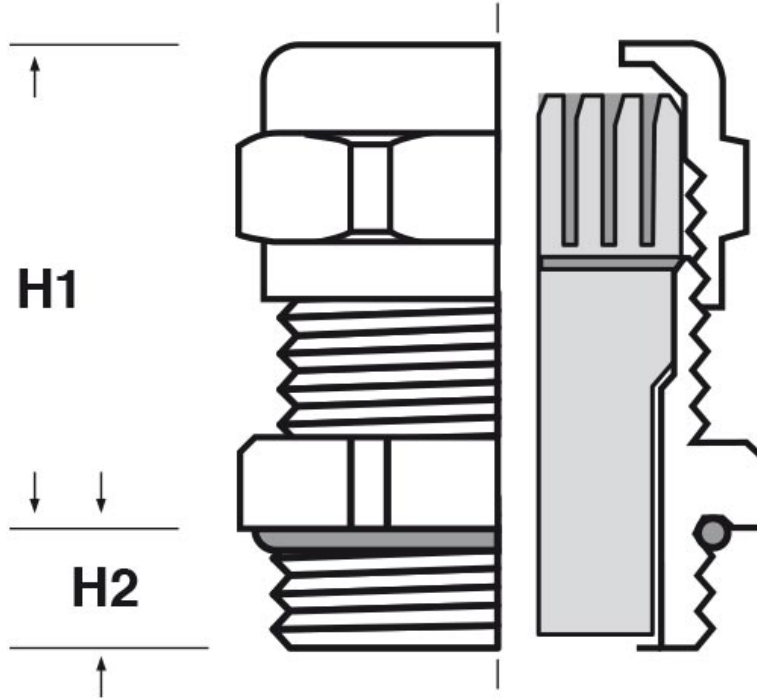

SCHEMA ARTICOLO

Articolo: EMC MET-S PG29.11.21 - Codice EZ: N.D

27/07/2024



ARTICOLO	filetto passo	filetto valore	Ø est. cavo min - max mm	chiave mm	H1 mm	H2 mm
EMC MET-S PG29.11.21	PG	29	11 - 21	40	30	8

Materiale: pressacavo in ottone nichelato, boccia lamellare in poliammide 6, O-Ring in nitrile 70 Sh A, guarnizione in neoprene 65 Sh A.

Guarnizione: -S (per serraggio lamellare)

Temperatura d'uso: -40°C / +100°C

Protezione IP: IP 68



Tutte le informazioni e i dati riportati sono indicativi e possono essere soggetti a variazioni senza preavviso

ELEKTROZUBEHÖR SPA

Sede:
Via F.lli Bronzetti, 24
20129 Milano (Italy)
Tel.: +39 02 701471
C.F. e P. IVA: 00729140152
Capitale Sociale: € 260.000

Centro logistico:
Via Cadorna, 66/A
20055 Vimodrone MI

Registro imprese: n° 92394 Tribunale di Milano
R.E.A.: 460657 - INTRASTAT: IT 00729140152
Posizione Import: MI 007993

