

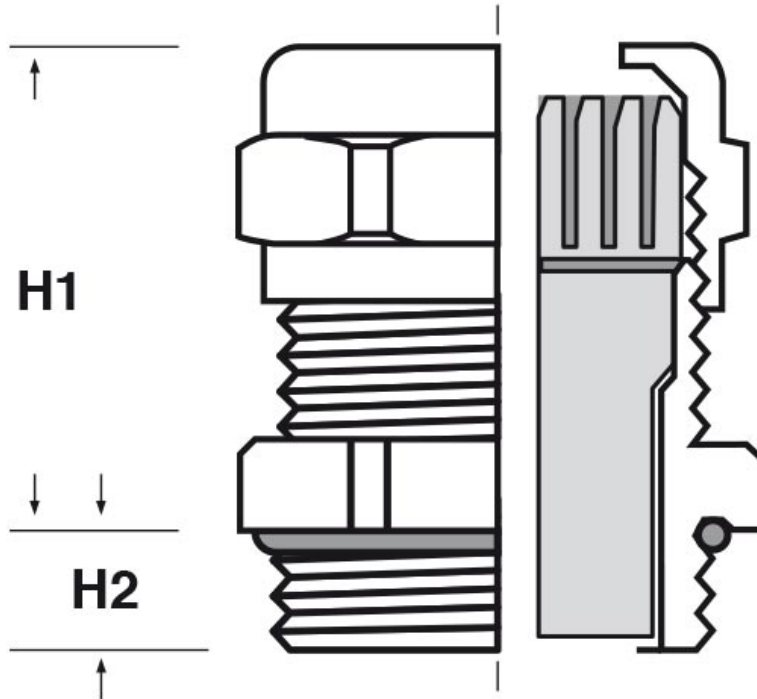

### SCHEMA ARTICOLO

Articolo: EMC MET-S M20.7.13 L15 - Codice EZ: N.D

24/07/2024



ARTICOLO	filetto passo	filetto valore	Ø est. cavo min - max mm	chiave mm	H1 mm	H2 mm
EMC MET-S M20.7.13 L15	Metrico	20	7 - 13	22	26	15

Materiale: pressacavo in ottone nichelato, boccia lamellare in poliammide 6, O-Ring in nitrile 70 Sh A, guarnizione in neoprene 65 Sh A.

Guarnizione: -S (per serraggio lamellare)

Temperatura d'uso: -40°C / +100°C

Protezione IP: IP 68



Tutte le informazioni e i dati riportati sono indicativi e possono essere soggetti a variazioni senza preavviso

### ELEKTROZUBEHÖR SPA

**Sede:**  
Via F.lli Bronzetti, 24  
20129 Milano (Italy)

Tel.: +39 02 701471  
C.F. e P. IVA: 00729140152  
Capitale Sociale: € 260.000

**Centro logistico:**  
Via Cadorna, 66/A  
20055 Vimodrone MI

Registro imprese: n° 92394 Tribunale di Milano  
R.E.A.: 460657 - INTRASTAT: IT 00729140152  
Posizione Import: MI 007993

