

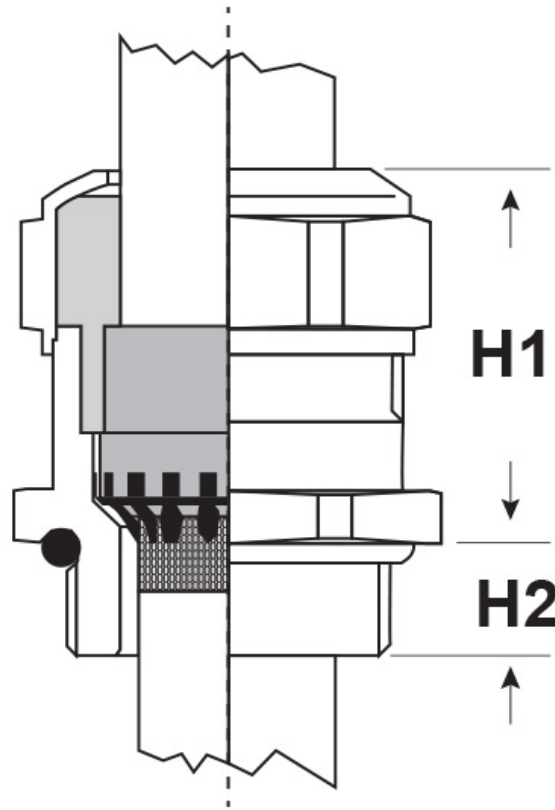

SCHEDA ARTICOLO

Articolo: 1081.20.110 - Codice EZ: 162765

25/07/2024



ARTICOLO	filetto passo	filetto valore	Ø est. cavo min - max mm	chiave mm	H1 mm	H2 mm
1081.20.110	Metrico	20x1,5	8 - 11	24	25	6

Materiale: pressacavo in ottone nichelato, boccia in ottone nichelato, griffe di contatto in acciaio inox A2, guarnizione in TPE, O-Ring in NBR.

Guarnizione: -FCP (a "fungo" corta)

Temperatura d'uso: -40°C / +100°C

Protezione IP: IP 68 (fino a 10 bar) / IP 69

Normative e Certificazioni: CE, VDE, c-UR-us, DNV GL, SEV, EAC.



Tutte le informazioni e i dati riportati sono indicativi e possono essere soggetti a variazioni senza preavviso

ELEKTROZUBEHÖR SPA

Sede:
Via F.lli Bronzetti, 24
20129 Milano (Italy)

Tel.: +39 02 701471
C.F. e P. IVA: 00729140152
Capitale Sociale: € 260.000

Centro logistico:
Via Cadorna, 66/A
20055 Vimodrone MI

Registro imprese: n° 92394 Tribunale di Milano
R.E.A.: 460657 - INTRASTAT: IT 00729140152
Posizione Import: MI 007993

