

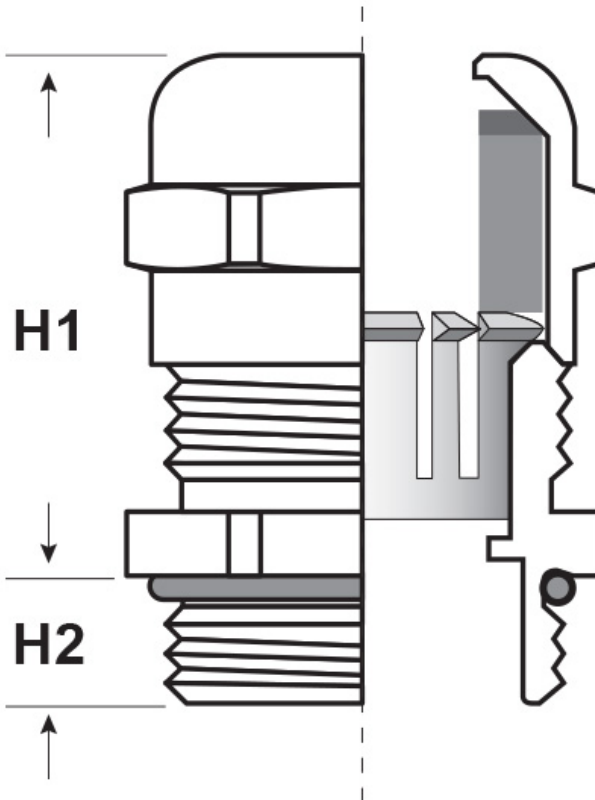

SCHEMA ARTICOLO

Articolo: EMC BOL-SAR PG11.7.10,5 - Codice EZ: 198682

25/07/2024



ARTICOLO	filetto passo	filetto valore	Ø est. cavo min - max mm	Ø est. calza min mm	chiave mm	H1 mm	H2 mm
EMC BOL-SAR PG11.7.10,5	PG	11	7 - 10,5	6	20	34	6

Materiale: pressacavo in ottone nichelato, griffe in plastica ramata e stagnata,
O-Ring in nitrile 70 Sh A, guarnizione in tefabloc 80 Sh A.

Guarnizione: -SAR (sagomata con griffe)

Temperatura d'uso: -25°C / +120°C

Protezione IP: IP 68



Tutte le informazioni e i dati riportati sono indicativi e possono essere soggetti a variazioni senza preavviso

ELEKTROZUBEHÖR SPA

Sede:
Via F.lli Bronzetti, 24
20129 Milano (Italy)

Tel.: +39 02 701471
C.F. e P. IVA: 00729140152
Capitale Sociale: € 260.000

Centro logistico:
Via Cadorna, 66/A
20055 Vimodrone MI

Registro imprese: n° 92394 Tribunale di Milano
R.E.A.: 460657 - INTRASTAT: IT 00729140152
Posizione Import: MI 007993

