

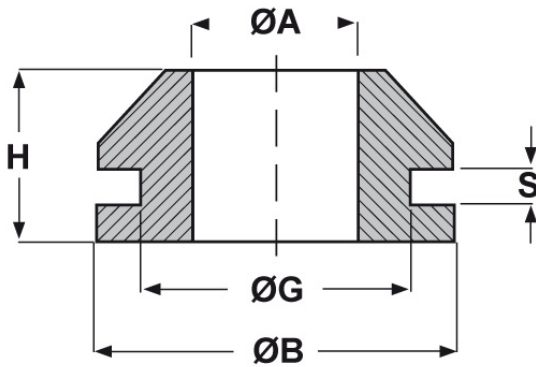

SCHEMA ARTICOLO

Articolo: KC 2,5-6-3 - Codice EZ: 131334

14/08/2024



forma A

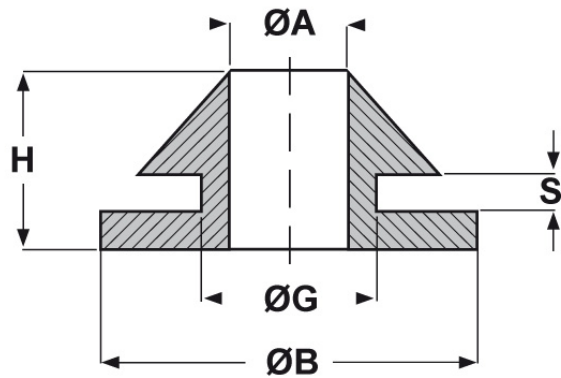

forma B

ARTICOLO	specifica	ØA mm	ØG mm	S mm	ØB mm	H mm
KC 2,5-6-3	forma B	2,5	6	3	9,5	9

Materiale: PVC.

Colore: nero.

Temperatura d'uso: -25°C / +60°C

Infiammabilità: antifiama e autoestinguente.

Tutte le informazioni e i dati riportati sono indicativi e possono essere soggetti a variazioni senza preavviso

ELEKTROZUBEHÖR SPA

Sede:
Via F.lli Bronzetti, 24
20129 Milano (Italy)
Tel.: +39 02 701471
C.F. e P. IVA: 00729140152
Capitale Sociale: € 260.000

Centro logistico:
Via Cadorna, 66/A
20055 Vimodrone MI

Registro imprese: n° 92394 Tribunale di Milano
R.E.A.: 460657 - INTRASTAT: IT 00729140152
Posizione Import: MI 007993

