

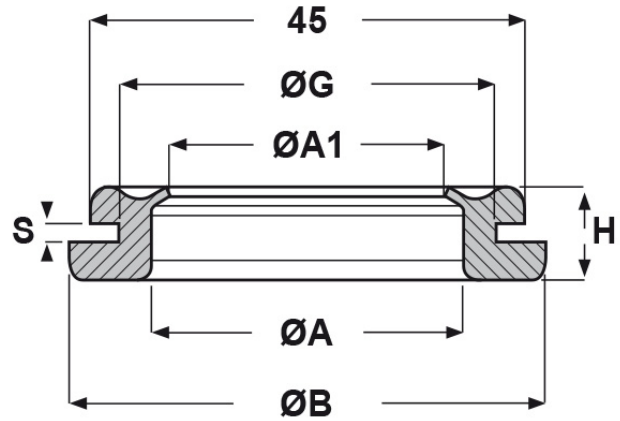

SCHEDA ARTICOLO

Articolo: DG 21/6 - Codice EZ: 130898

20/07/2024

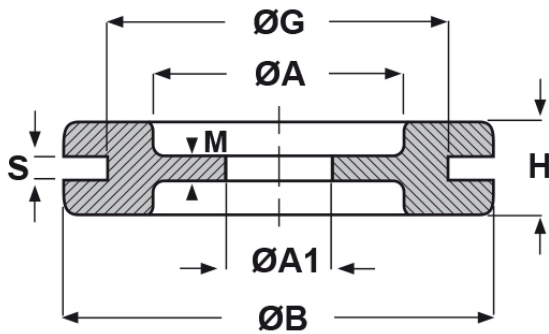

15-808

ARTICOLO	ØA mm	ØG mm	S mm	ØA1 mm	ØB mm	H mm	M mm
DG 21/6	21	28	2	6	35	8	1

Materiale: neoprene.

Colore: nero.

Temperatura d'uso: -30°C / +90°C

Tutte le informazioni e i dati riportati sono indicativi e possono essere soggetti a variazioni senza preavviso

ELEKTROZUBEHÖR SPA

Sede:
Via F.lli Bronzetti, 24
20129 Milano (Italy)

Tel.: +39 02 701471
C.F. e P. IVA: 00729140152
Capitale Sociale: € 260.000

Centro logistico:
Via Cadorna, 66/A
20055 Vimodrone MI

Registro imprese: n° 92394 Tribunale di Milano
R.E.A.: 460657 - INTRASTAT: IT 00729140152
Posizione Import: MI 007993

