

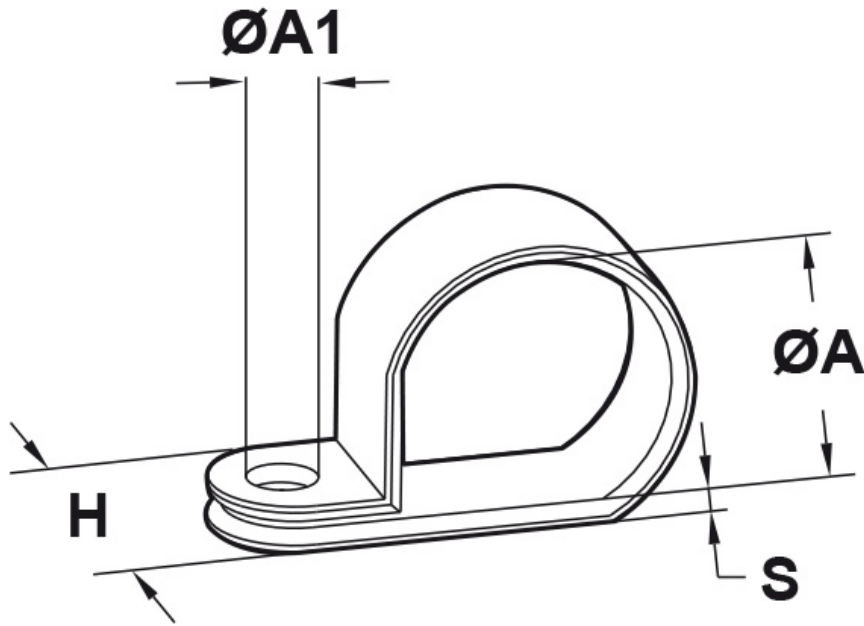

SCHEMA ARTICOLO

Articolo: 3362 - Codice EZ: 305470

27/07/2024



ARTICOLO	colore	H mm	ØA mm	ØA1 mm	S mm
3362	nero	9,5	3,2	4,3	1,3

Materiale: poliammide 66.

Colore: nero o naturale.

Temperatura d'uso: max +85°C

Infiammabilità: antifiama e autoestinguente UL94-V2.

Normative e Certificazioni: UR.



Tutte le informazioni e i dati riportati sono indicativi e possono essere soggetti a variazioni senza preavviso

ELEKTROZUBEHÖR SPA

Sede:
Via F.lli Bronzetti, 24
20129 Milano (Italy)

Tel.: +39 02 701471
C.F. e P. IVA: 00729140152
Capitale Sociale: € 260.000

Centro logistico:
Via Cadorna, 66/A
20055 Vimodrone MI

Registro imprese: n° 92394 Tribunale di Milano
R.E.A.: 460657 - INTRASTAT: IT 00729140152
Posizione Import: MI 007993

