

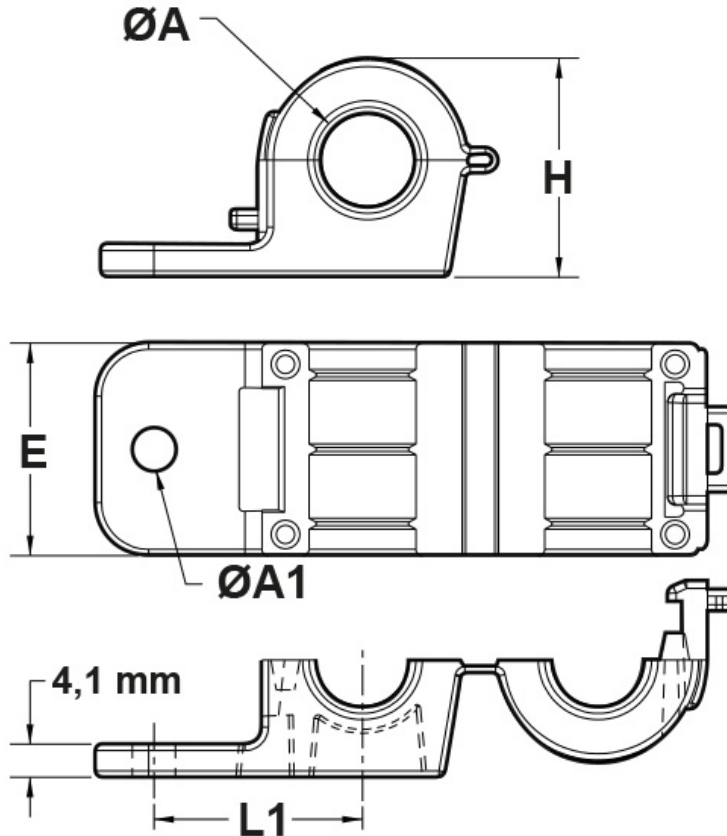

SCHEMA ARTICOLO

Articolo: HDLCC 750-330 NERI - Codice EZ: N.D

27/07/2024



ARTICOLO	colore	materiale	ØA mm	ØA1 mm	H mm	E mm	L1 mm
HDLCC 750-330 NERI	nero	PA 66	19,1	8,4	33	31,8	30,7

Materiale: poliammide 66 UL94-V2 (PA 66) o poliammide 66 UL94-V0 (PA 66-V0).

Colore: nero, grigio.

Temperatura d'uso: max +105°C

Infiammabilità: antifiama e autoestinguente UL94-V2 o UL94-V0.

Tutte le informazioni e i dati riportati sono indicativi e possono essere soggetti a variazioni senza preavviso

ELEKTROZUBEHÖR SPA

Sede:
Via F.lli Bronzetti, 24
20129 Milano (Italy)

Tel.: +39 02 701471
C.F. e P. IVA: 00729140152
Capitale Sociale: € 260.000

Centro logistico:
Via Cadorna, 66/A
20055 Vimodrone MI

Registro imprese: n° 92394 Tribunale di Milano
R.E.A.: 460657 - INTRASTAT: IT 00729140152
Posizione Import: MI 007993

