

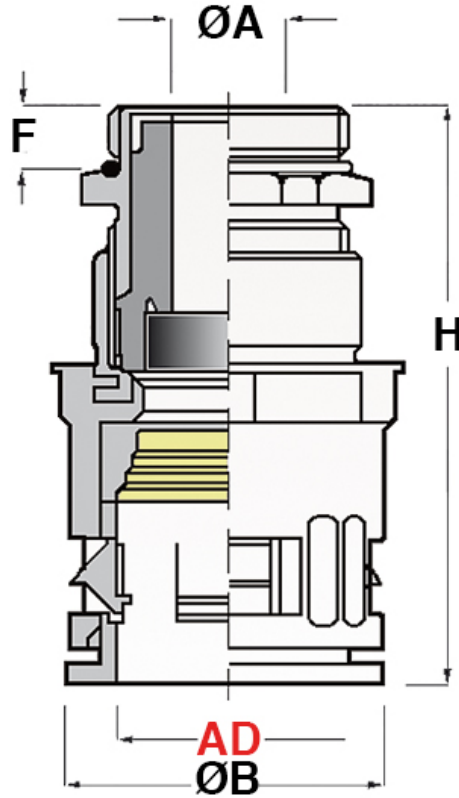

**SCHEDA ARTICOLO**

Articolo: RQGKZP-M 40.20.25 AD34,5 L8 NERI - Codice EZ: N.D

26/10/2024



**Il disegno è indicativo e le proporzioni potrebbero non corrispondere alle dimensioni in tabella o reali.**

ARTICOLO	specificata	Ø esterno tubo AD	filetto passo	filetto valore	Ø est. cavo min - max mm	ØA mm	ØB mm	F mm	H mm	chiave mm
RQGKZP-M 40.20.25 AD34,5 L8 NERI	RQGKZP	34,5	Metrico	40x1,5	20 - 25	27,5	48	8	75	42/43

Materiale: corpo del raccordo in poliammide 6, guarnizione interna in TPE, corpo del pressacavo e filetto in ottone nichelato.

Colore: nero.

Temperatura d'uso: -40°C / +120°C

Protezione IP: IP 68, IP 69.

Infiammabilità: antifiamma e autoestinguento UL94-V0 (poliammide 6).

Normative e Certificazioni: VDE (EN/IEC 61386-23), DIN EN 45545-2 HL3, DIN EN 45545-3 E30 (soltanto per i raccordi RQGKZP), DB (DIN 5510), SNCF, LLOYD'S REGISTER (soltanto per i raccordi RQGKZ), c-UR-us (UL 1696 / CSA 22.2; file n. E86359, per le misure AD13-AD54,5), GOST, UKCA.



Tutte le informazioni e i dati riportati sono indicativi e possono essere soggetti a variazioni senza preavviso

**ELEKTROZUBEHÖR SPA**

**Sede:**  
Via F.lli Bronzetti, 24  
20129 Milano (Italy)  
Tel.: +39 02 701471  
C.F. e P. IVA: 00729140152  
Capitale Sociale: € 260.000

**Centro logistico:**  
Via Cadorna, 66/A  
20055 Vimodrone MI

Registro imprese: n° 92394 Tribunale di Milano  
R.E.A.: 460657 - INTRASTAT: IT 00729140152  
Posizione Import: MI 007993

