

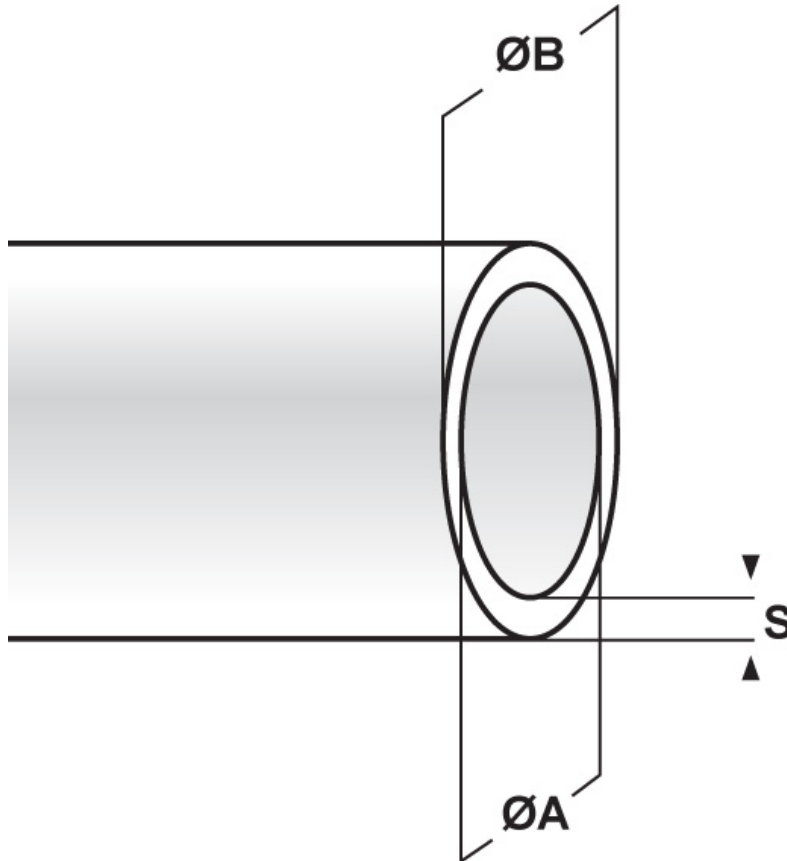

SCHEMA ARTICOLO

Articolo: PS 18 BLU - Codice EZ: N.D

16/07/2024



ARTICOLO	colore	ØA mm	ØB mm	S mm
PS 18 BLU	blu	18	19,2	0,6

Materiale: PVC.	Colore: nero, bianco, blu, giallo, rosso, verde, grigio, trasparente.
Temperatura d'uso: max +70°C	Infiammabilità: antifiama UL94-HB.

Tutte le informazioni e i dati riportati sono indicativi e possono essere soggetti a variazioni senza preavviso

ELEKTROZUBEHÖR SPA

Sede:
Via F.lli Bronzetti, 24
20129 Milano (Italy)
Tel.: +39 02 701471
C.F. e P. IVA: 00729140152
Capitale Sociale: € 260.000

Centro logistico:
Via Cadorna, 66/A
20055 Vimodrone MI

Registro imprese: n° 92394 Tribunale di Milano
R.E.A.: 460657 - INTRASTAT: IT 00729140152
Posizione Import: MI 007993

