

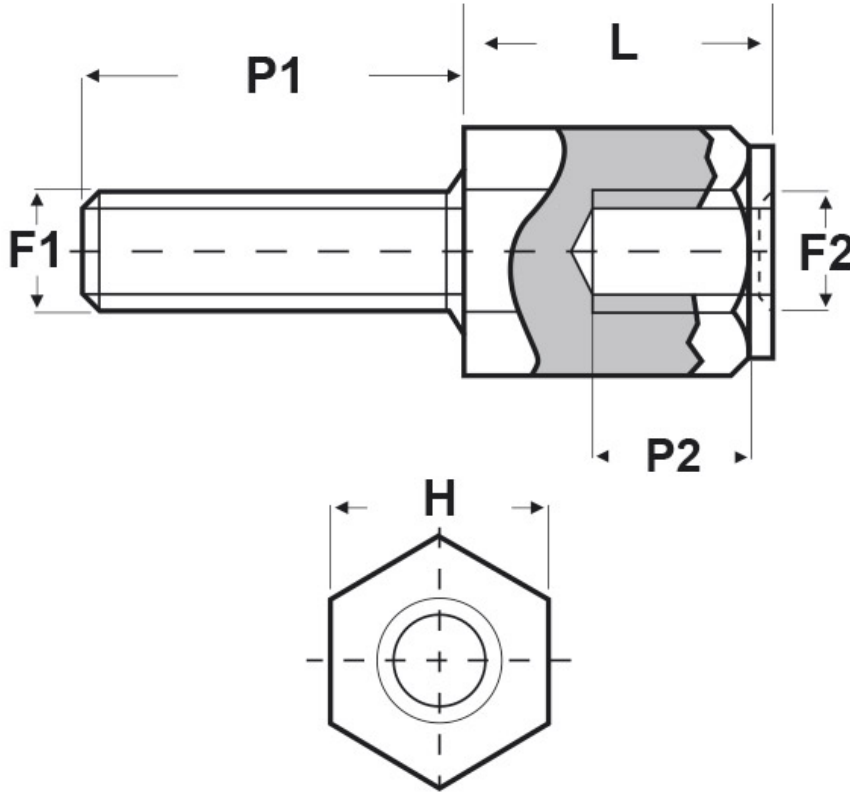

**SCHEMA ARTICOLO**

Articolo: MF06 H 40-3080.8 38 PA66 NERI - Codice EZ: N.D.

16/07/2024



ARTICOLO	filetto passo F1	filetto valore F1	filetto passo F2	filetto valore F2	H mm	L mm	P1 mm	P2 min mm
MF06 H 40-3080.8 38 PA66 NERI	Metrico	4	Metrico	3	8	38	8	10

Materiale: poliammide 66.	Colore: nero.
Temperatura d'uso: -30°C / +150°C	

Tutte le informazioni e i dati riportati sono indicativi e possono essere soggetti a variazioni senza preavviso

**ELEKTROZUBEHÖR SPA**

**Sede:**  
Via F.lli Bronzetti, 24  
20129 Milano (Italy)  
Tel.: +39 02 701471  
C.F. e P. IVA: 00729140152  
Capitale Sociale: € 260.000

**Centro logistico:**  
Via Cadorna, 66/A  
20055 Vimodrone MI

Registro imprese: n° 92394 Tribunale di Milano  
R.E.A.: 460657 - INTRASTAT: IT 00729140152  
Posizione Import: MI 007993

