

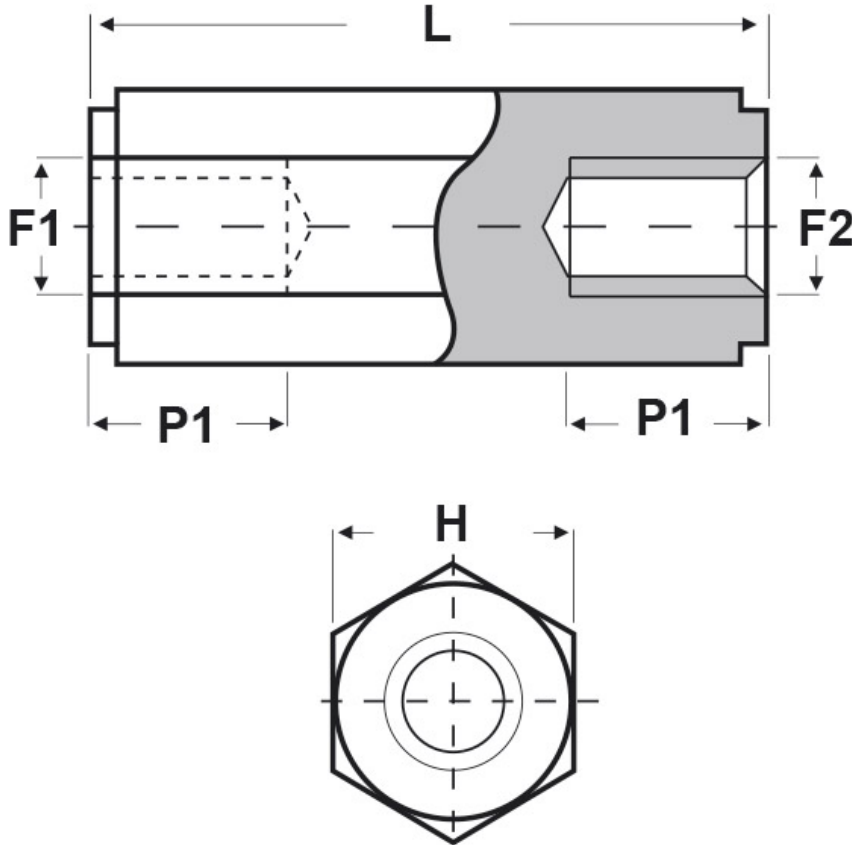

SCHEMA ARTICOLO

Articolo: FF09 H 3070 33 PA6-RV NERI - Codice EZ: N.D.

20/07/2024



ARTICOLO	filetto passo F1	filetto valore F1	filetto passo F2	filetto valore F2	H mm	L mm	P1 mm
FF09 H 3070 33 PA6-RV NERI	Metrico	3	Metrico	3	7	33	10

Materiale: poliammide 6 rinforzato con fibra di vetro (25%-30%).

Colore: nero.

Temperatura d'uso: -30°C / +110°C

Tutte le informazioni e i dati riportati sono indicativi e possono essere soggetti a variazioni senza preavviso

ELEKTROZUBEHÖR SPA

Sede:
Via F.lli Bronzetti, 24
20129 Milano (Italy)

Tel.: +39 02 701471
C.F. e P. IVA: 00729140152
Capitale Sociale: € 260.000

Centro logistico:
Via Cadorna, 66/A
20055 Vimodrone MI

Registro imprese: n° 92394 Tribunale di Milano
R.E.A.: 460657 - INTRASTAT: IT 00729140152
Posizione Import: MI 007993

