

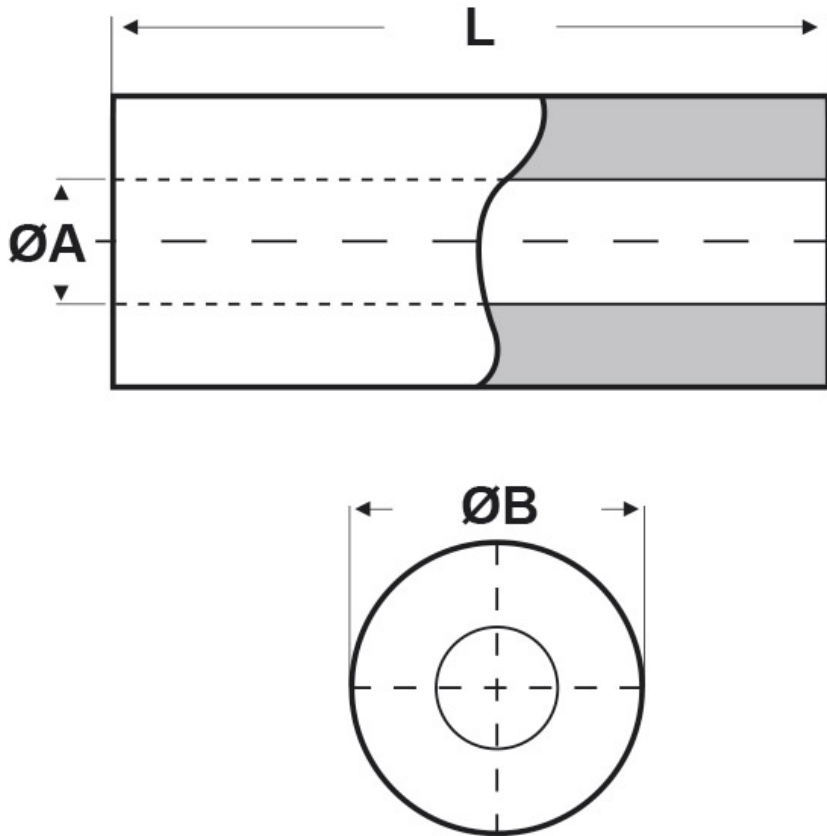

SCHEMA ARTICOLO

Articolo: DCK R 103220 10 PA66 NT - Codice EZ: 339609

27/07/2024



ARTICOLO	materiale	ØA mm	ØB mm	L mm
DCK R 103220 10 PA66 NT	PA 66	10,6	22	10

Materiale: poliammide 66 (PA66) e POM.

Colore: naturale.

Temperatura d'uso: max +120°C (PA66), max +100°C (POM)

Tutte le informazioni e i dati riportati sono indicativi e possono essere soggetti a variazioni senza preavviso

ELEKTROZUBEHÖR SPA

Sede:
Via F.lli Bronzetti, 24
20129 Milano (Italy)

Tel.: +39 02 701471
C.F. e P. IVA: 00729140152
Capitale Sociale: € 260.000

Centro logistico:
Via Cadorna, 66/A
20055 Vimodrone MI

Registro imprese: n° 92394 Tribunale di Milano
R.E.A.: 460657 - INTRASTAT: IT 00729140152
Posizione Import: MI 007993

