

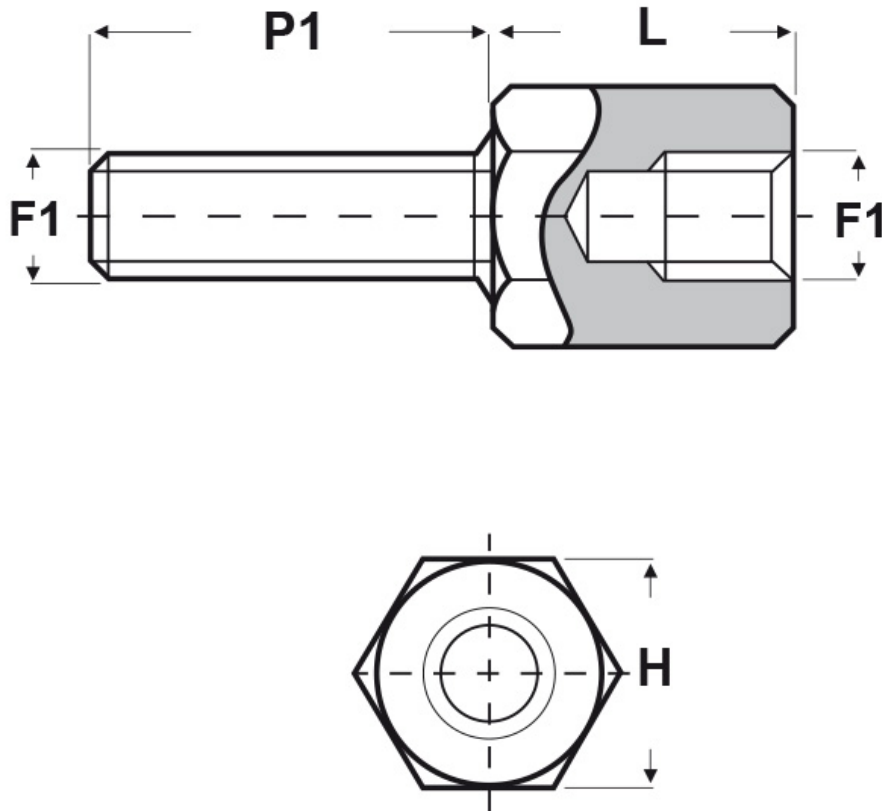

SCHEMA ARTICOLO

Articolo: SD-UD E 4NC 8 - Codice EZ: 351849

14/08/2024



ARTICOLO	filetto passo F1	filetto valore F1	H mm	L mm	P1 mm
SD-UD E 4NC 8	UNC	4	5	5	8

Materiale: distanziatori e dado in ottone nichelato, rondella zigrinata in acciaio.

Tutte le informazioni e i dati riportati sono indicativi e possono essere soggetti a variazioni senza preavviso

ELEKTROZUBEHÖR SPA

Sede:
Via F.lli Bronzetti, 24
20129 Milano (Italy)

Tel.: +39 02 701471
C.F. e P. IVA: 00729140152
Capitale Sociale: € 260.000

Centro logistico:
Via Cadorna, 66/A
20055 Vimodrone MI

Registro imprese: n° 92394 Tribunale di Milano
R.E.A.: 460657 - INTRASTAT: IT 00729140152
Posizione Import: MI 007993

