

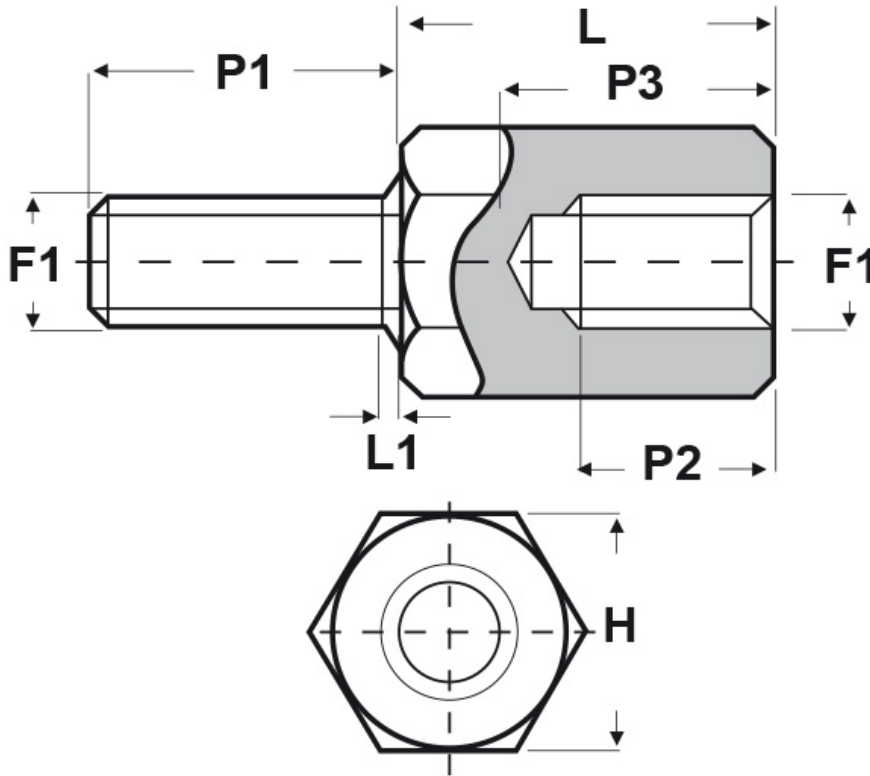

**SCHEMA ARTICOLO**

Articolo: MF30 H 3050 30 - Codice EZ: 351258

25/07/2024



ARTICOLO	filetto passo F1	filetto valore F1	H mm	L mm	L1 max mm	P1 mm	P2 min mm	P3 max mm
MF30 H 3050 30	Metrico	3	5	30	1	10	10	15

Materiale: acciaio zincato.

Colore: argentato.

Tutte le informazioni e i dati riportati sono indicativi e possono essere soggetti a variazioni senza preavviso

**ELEKTROZUBEHÖR SPA**

**Sede:**  
Via F.lli Bronzetti, 24  
20129 Milano (Italy)

Tel.: +39 02 701471  
C.F. e P. IVA: 00729140152  
Capitale Sociale: € 260.000

**Centro logistico:**  
Via Cadorna, 66/A  
20055 Vimodrone MI

Registro imprese: n° 92394 Tribunale di Milano  
R.E.A.: 460657 - INTRASTAT: IT 00729140152  
Posizione Import: MI 007993

