

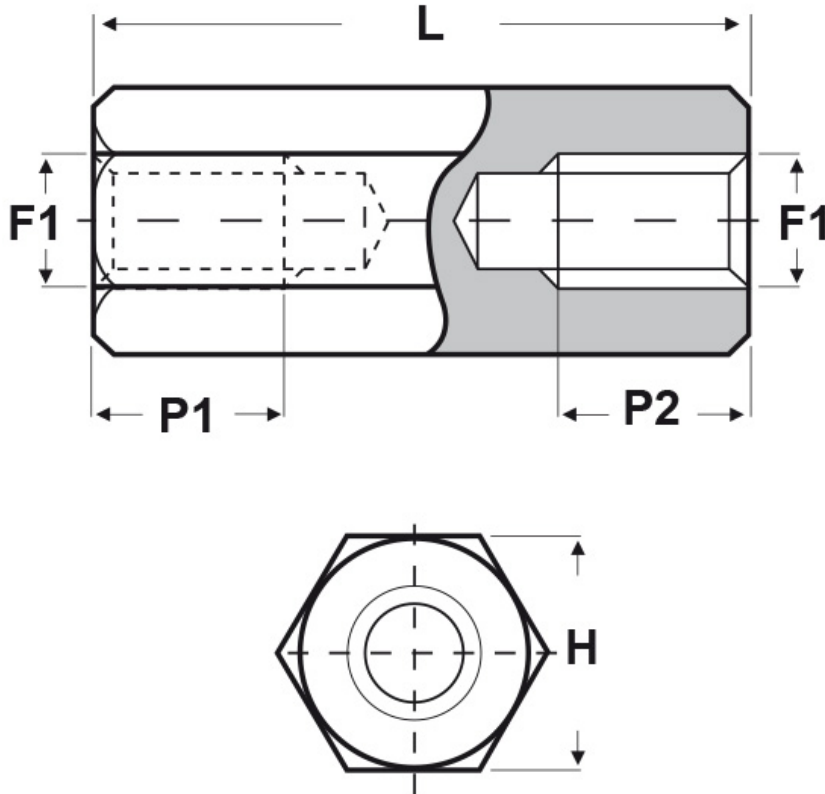

SCHEMA ARTICOLO

Articolo: DD10 E 4070 30 - Codice EZ: N.D.

18/07/2024



ARTICOLO	filetto passo F1	filetto valore F1	H mm	L mm	P1 min mm	P2 min mm
DD10 E 4070 30	Metrico	4	7	30	-	-

Materiale: ottone nichelato.

Colore: argentato.

Tutte le informazioni e i dati riportati sono indicativi e possono essere soggetti a variazioni senza preavviso

ELEKTROZUBEHÖR SPA

Sede:
Via F.lli Bronzetti, 24
20129 Milano (Italy)

Tel.: +39 02 701471
C.F. e P. IVA: 00729140152
Capitale Sociale: € 260.000

Centro logistico:
Via Cadorna, 66/A
20055 Vimodrone MI

Registro imprese: n° 92394 Tribunale di Milano
R.E.A.: 460657 - INTRASTAT: IT 00729140152
Posizione Import: MI 007993

