

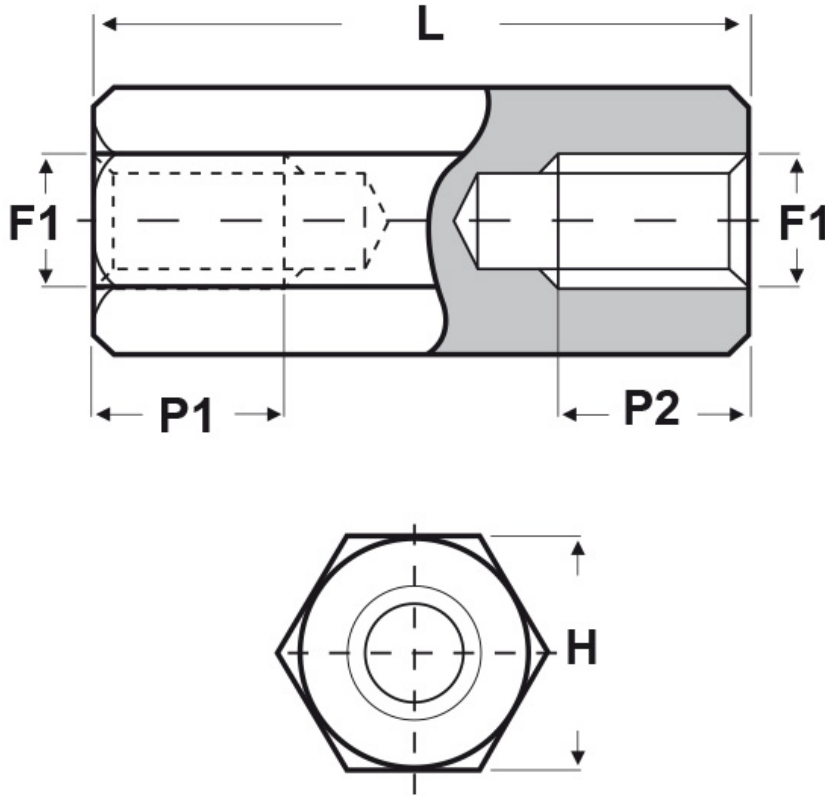

**SCHEMA ARTICOLO**

Articolo: DD10 E 4060 12 - Codice EZ: 356226

24/07/2024



ARTICOLO	filetto passo F1	filetto valore F1	H mm	L mm	P1 min mm	P2 min mm
DD10 E 4060 12	Metrico	4	6	12	-	-

Materiale: ottone nichelato.

Colore: argentato.

Tutte le informazioni e i dati riportati sono indicativi e possono essere soggetti a variazioni senza preavviso

**ELEKTROZUBEHÖR SPA**

**Sede:**  
Via F.lli Bronzetti, 24  
20129 Milano (Italy)

Tel.: +39 02 701471  
C.F. e P. IVA: 00729140152  
Capitale Sociale: € 260.000

**Centro logistico:**  
Via Cadorna, 66/A  
20055 Vimodrone MI

Registro imprese: n° 92394 Tribunale di Milano  
R.E.A.: 460657 - INTRASTAT: IT 00729140152  
Posizione Import: MI 007993

