

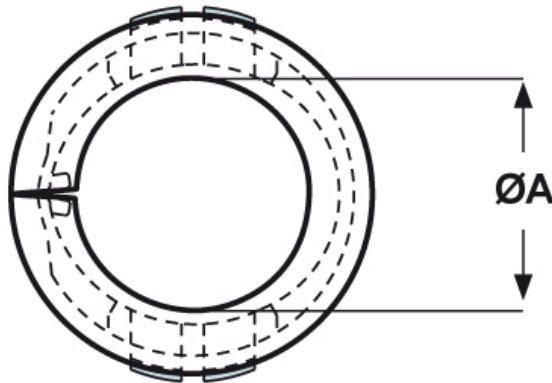

SCHEMA ARTICOLO

Articolo: OCB-625 - Codice EZ: 142567

22/07/2024

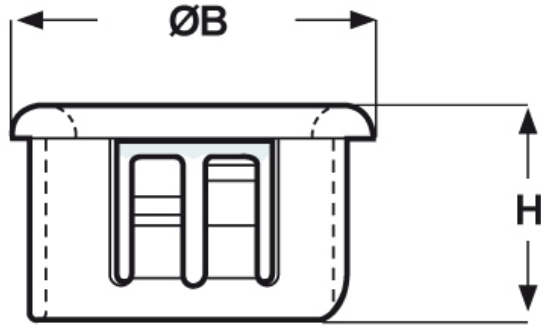

ARTICOLO	ØA mm	ØB mm	H mm	spessore telaio max mm	Ø foro montaggio mm
OCB-625	11,5	17,5	10,3	3,2	15,9

Materiale: poliammide 6/6.

Colore: nero.

Temperatura d'uso: max +105°C

Infiammabilità: antifiama e autoestinguente UL94-V2.



Tutte le informazioni e i dati riportati sono indicativi e possono essere soggetti a variazioni senza preavviso

ELEKTROZUBEHÖR SPA

Sede:
Via F.lli Bronzetti, 24
20129 Milano (Italy)

Tel.: +39 02 701471
C.F. e P. IVA: 00729140152
Capitale Sociale: € 260.000

Centro logistico:
Via Cadorna, 66/A
20055 Vimodrone MI

Registro imprese: n° 92394 Tribunale di Milano
R.E.A.: 460657 - INTRASTAT: IT 00729140152
Posizione Import: MI 007993

